

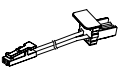

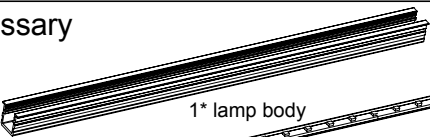

INSTALLATION MANUAL

Product & accessory  1* solder-free conductive connector  1* lamp body  1* LED strip  1* PC cover		 1* end cap  2* installation bracket	Tools for installation  electric drill  drill bit
--	--	---	--

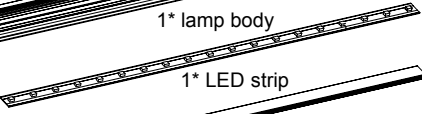
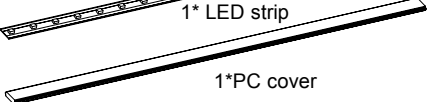

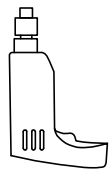
The lamp body can be cut to length by manufacturer or by yourself according to the demand.

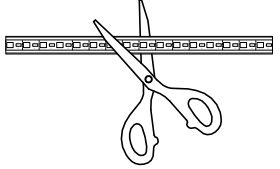

Cutable every group(single diode and resistor)to avoid waste and reduce dark area.

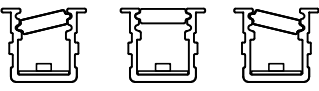

gradient glow straight glow gradient glow

Multi-angle light glow options, can be straight or gradient

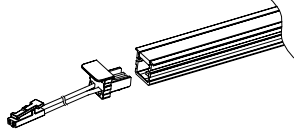

Plug and play design for easy installation and use with conductive connector free of soldering. Left cable and right cable installation universal.

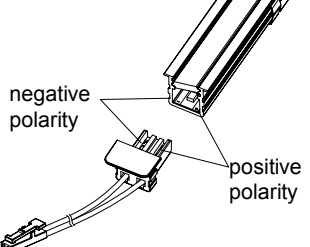

negative polarity
positive polarity

Insert the solder-free conductive connector into the lamp body, connect it to LED driver and power cord to see if the lamp works normally. (Note the positive and negative polarity connection)

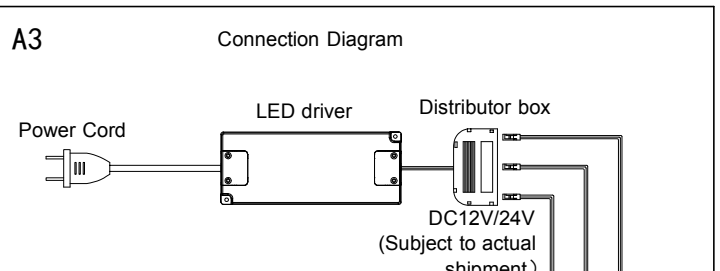

A1

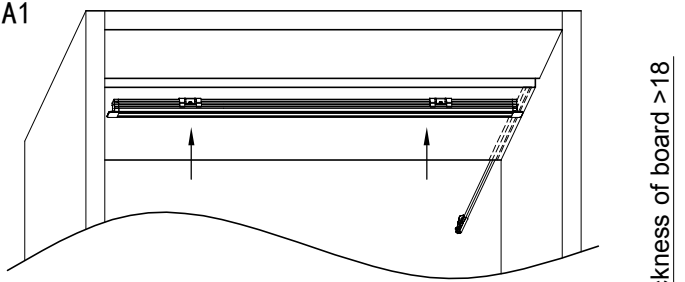

1: Make slot for lamp body and wire on the board surface with milling cutter.
2: Clamp the lamp body into the slot as picture shown

10 10 thickness of board > 18

A2

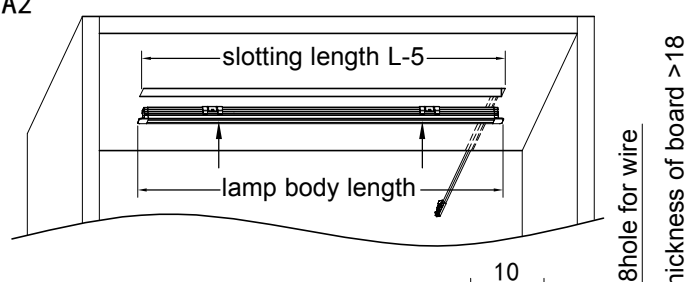

slotting length L-5
lamp body length

1: Make slot for lamp body and wire on the board surface with milling cutter.
2: Drill hole for wire with a milling cutter on the board surface.
3: Clamp the lamp body into the slot as picture shown.

10 Ø8 hole for wire thickness of board > 18

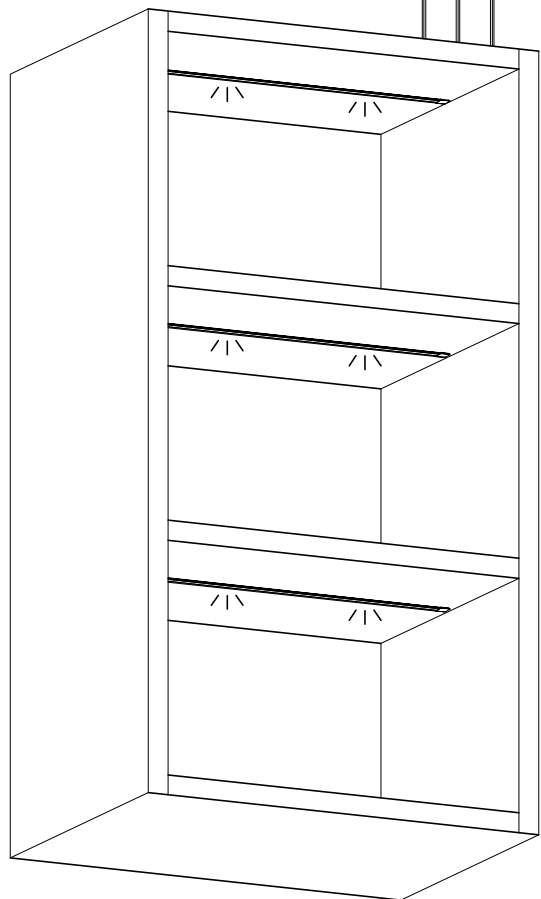

INSTALLATION MANUAL

Product & accessory

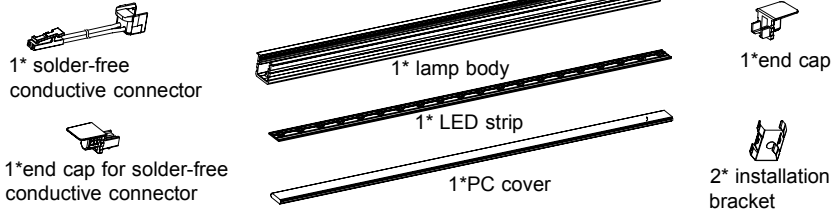

Tools for installation

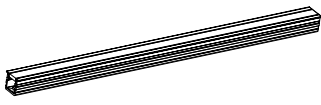
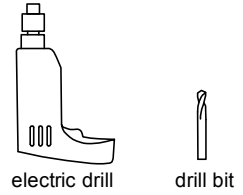

The lamp body can be cut to length by manufacturer or by yourself according to the demand.

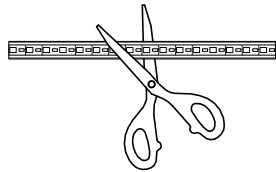

Cuttable every group (single diode and resistor) to avoid waste and reduce dark area.

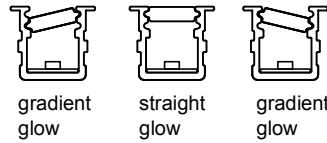

Multi-angle light glow options, can be straight or gradient

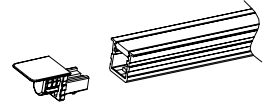

Plug and play design for easy installation and use with conductive connector free of soldering. Left cable and right cable installation universal.

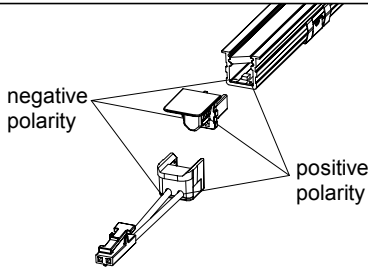

Insert the end cap solder-free conductive connector into the lamp body (Note the positive and negative polarity connection)

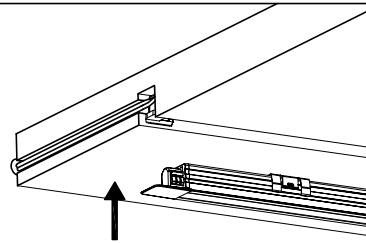

Lamp body and wire separated for easier maintenance and replacement in case of defective LED strips, no need to remove furniture board and re-arrange cables.

A1

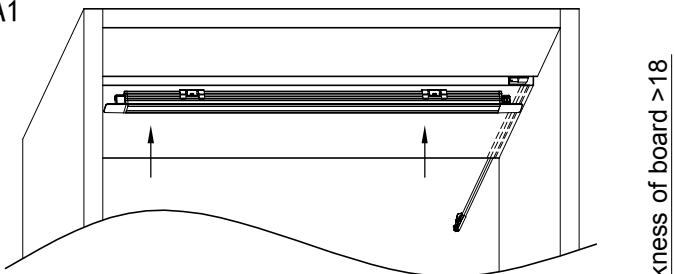

- 1: Make slot for lamp body and wire on the board surface with milling cutter.
- 2: Clamp the solder-free conductive connector into the slot as picture shown.
- 3: Clamp the lamp body into the slot and make sure to connect with the solder-free conductive connector.

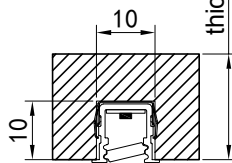

A3

Connection Diagram

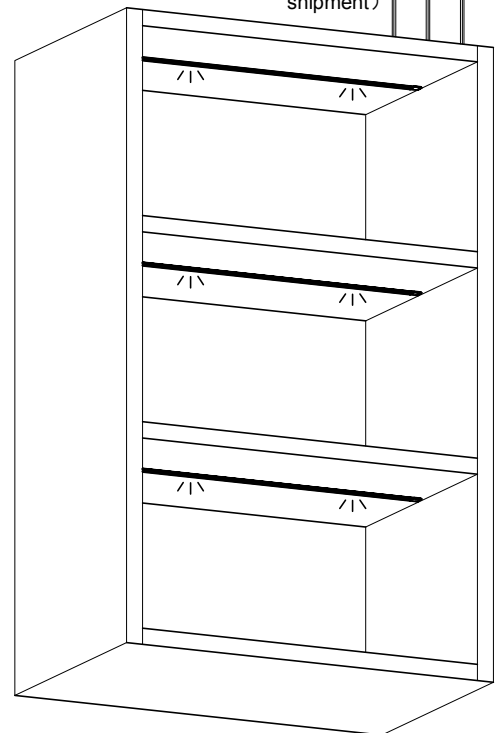
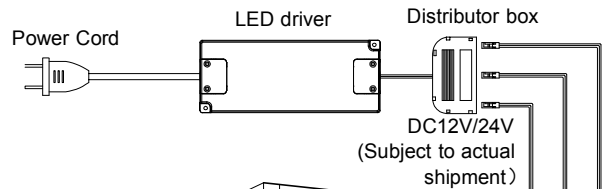

A2

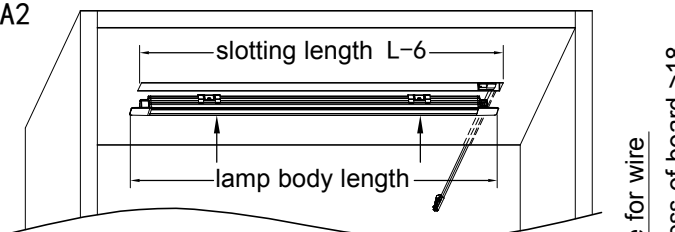

- 1: Make slot for lamp body and wire on the board surface with milling cutter.
- 2: Drill hole for wire with a milling cutter on the board surface.
- 3: Clamp the solder-free conductive connector into the slot as picture shown.
- 4: Clamp the lamp body into the slot and make sure to connect with the solder-free conductive connector.

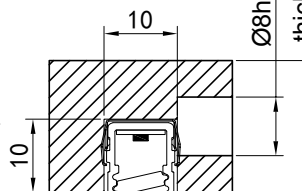

INSTALLATION MANUAL

Product & accessory

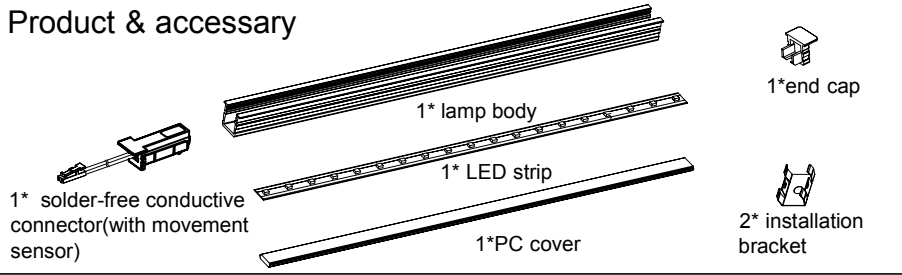

Tools for installation

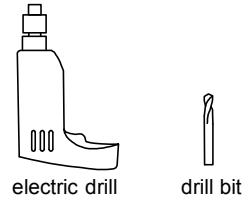

The lamp body can be cut to length by manufacturer or by yourself according to the demand.

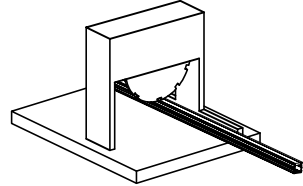

Cutttable every group (single diode and resistor) to avoid waste and reduce dark area.

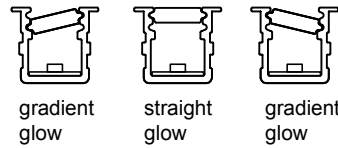

Multi-angle light glow options, can be straight or gradient

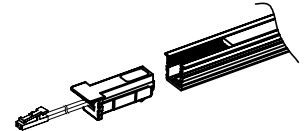

Plug and play design for easy installation and use with conductive connector free of soldering. Left cable and right cable installation universal.

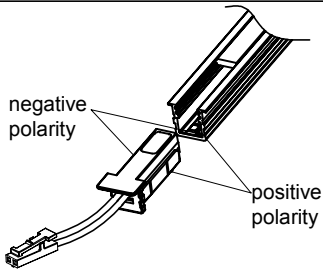

Insert the solder-free conductive connector (with movement sensor) into the lamp body, connect it to LED driver and power cord to see if the lamp works normally. (Note the positive and negative polarity connection)

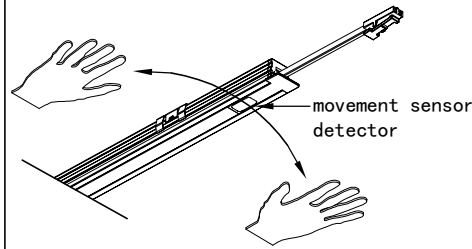

Wave hand within detective range $< 0.5S$ to switch on/off the lamp, stay hand $> 0.5S$ to dim up/down the lamp steplessly from 10% to 100% brightness.

A1

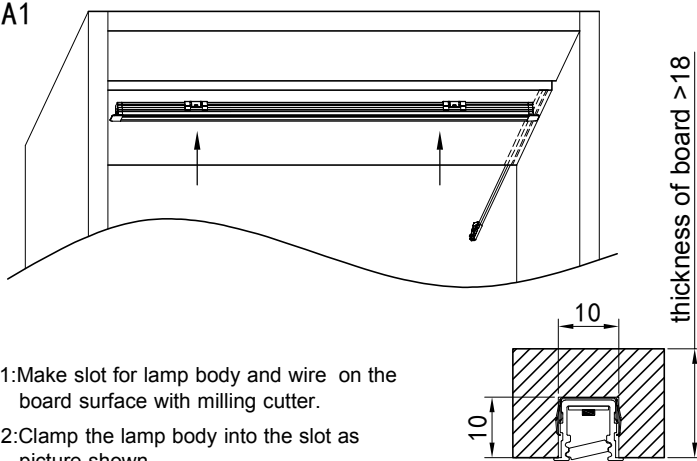

- 1: Make slot for lamp body and wire on the board surface with milling cutter.
- 2: Clamp the lamp body into the slot as picture shown

A3

Connection Diagram

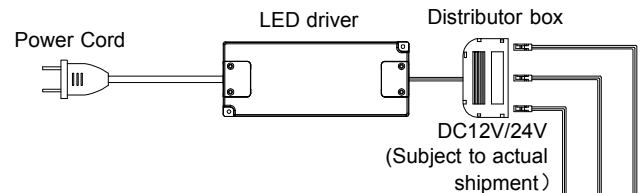

A2

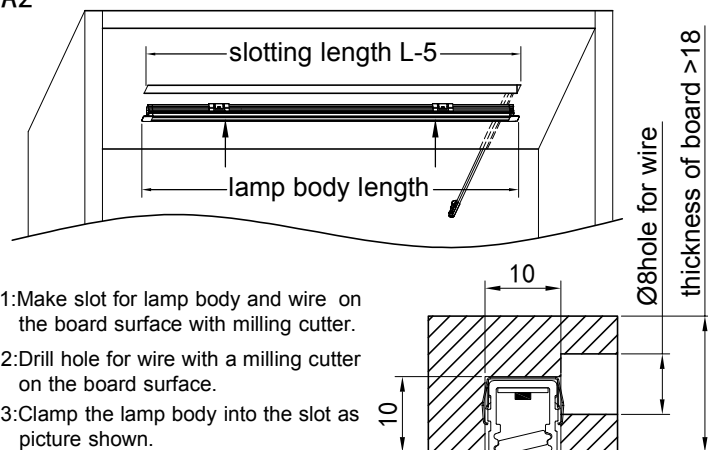

- 1: Make slot for lamp body and wire on the board surface with milling cutter.
- 2: Drill hole for wire with a milling cutter on the board surface.
- 3: Clamp the lamp body into the slot as picture shown.

